

Roomba Pro  
Roomba Pro Elite

**Roomba™**  
ROBOTIC FLOORVAC

iRobot and Roomba are trademarks of iRobot Corporation.

© 2002, 2003 iRobot Corporation.  
All rights reserved.  
Patents Pending.

Made & Printed in China.

To order extra Batteries, Virtual Wall Units, Replacement Filters  
or the Rapid Charger, contact your nearest Roomba retailer,  
or visit [www.RoombaVac.com](http://www.RoombaVac.com) for online purchase options  
and additional purchase information.

**iRobot™**  
[www.irobot.com](http://www.irobot.com)

Part # 8786 (R1B-1)

**Roomba™**  
ROBOTIC FLOORVAC

# Owner's Manual

Before using your Roomba, thoroughly read the safety instructions.

## Important Safety Instructions

CAUTION: TO REDUCE THE RISK OF ELECTRIC SHOCK, DO NOT REMOVE COVER OF ROOMBA, ITS BATTERY OR THE CHARGER AC ADAPTER. NO USER-SERVICEABLE PARTS INSIDE. REFER SERVICING TO QUALIFIED SERVICE PERSONNEL. CHARGE USING STANDARD US (120V AC) OUTLET ONLY.

Always be careful when using your Roomba. To reduce the risk of injury or damage, keep these safety precautions in mind when setting up, using and maintaining your equipment.

### General

- Read all safety and operating instructions before operating Roomba.
- Retain the safety and operating instructions for future reference.
- Heed all warnings on Roomba, Battery, Charger AC Adapter and in Owner's Manual.
- Follow all operating and use instructions.
- Do not attempt to service Roomba yourself. Refer all non-routine servicing to qualified service personnel.

### Roomba Use

- Roomba is an indoor device only.
- Do not use Roomba on wet surfaces or where contact with or immersion in water is a possibility.
- Before using this appliance, pick up objects like clothing, loose papers, pull cords for blinds or curtains, power cords, and any fragile objects. If the device passes over a power cord and drags it around, there is a chance an object could tumble off a table or shelf.
- Roomba is not a toy. Do not sit or stand on this device. Small children and pets should be supervised if Roomba is in use.
- Keep loose clothing, hair, fingers, feet and all parts of the body away from Brushes and moving parts.
- Do not use this device to pick up anything that is burning or smoking, such as cigarettes, matches, or hot ashes.
- Do not use this device to pick up flammable or combustible liquids such as gasoline.
- Do not use this device without the Particle Bin in place. See page 16 for proper installation of the Particle Bin.
- If the room to be cleaned contains a balcony, a physical barrier should be used to prevent access to the balcony and ensure safe operation.
- Always remove the Battery before long-term storage or transportation.

### Roomba Battery and Charging

- Operate your Roomba only from the type of power source indicated on the marking label. If you are not sure of the type of power supplied to your home, consult your appliance dealer or local power company.
- Charge using standard US (120V AC) outlet only. Product may not be used with any type of power converter. Any such use will immediately void the Warranty. (Note: If you live outside the U.S., compatible versions of Roomba are available in many countries. Check local retailers for availability.)
- Use only the Charger AC Adapter or Rapid Charger supplied by the manufacturer to recharge this device.
- Do not use a Charger AC Adapter with a damaged cord or plug.
- Charge indoors only.
- Never handle Charger AC Adapter with wet hands.
- Always remove the Battery and disconnect Roomba from the Charger AC Adapter before cleaning Roomba.

# Owner's Manual

## Contents

<b>Important Safety Instructions</b>	<b>2</b>
<b>Introducing Your Roomba Pro FloorVac</b>	<b>4</b>
<b>Getting Started</b>	<b>5</b>
• Unpacking the Box	5
• FloorVac Description	6
• Installing the Battery	7
• Removing the Battery	7
• Charging the Battery	7
- <i>The Battery Indicator Light</i>	8
<b>Using Your Roomba</b>	<b>8</b>
• Preparing the Room for Cleaning	8
• Starting Roomba	9
• Pausing and Stopping Roomba	10
- <i>Pausing Roomba in a Cleaning Cycle</i>	10
- <i>Spot Cleaning while Paused</i>	10
- <i>Un-Pausing Roomba</i>	10
- <i>Stopping Roomba</i>	10
• The Virtual Wall Units	11
- <i>Virtual Wall Unit Battery Installation</i>	11
- <i>Using the Virtual Wall Unit</i>	12
• The Roomba Remote (included with Roomba Pro Elite)	12
- <i>Roomba Remote Battery Installation</i>	12
- <i>Using the Roomba Remote</i>	13
- <i>Using the Roomba Remote with Roomba Pro</i>	14
• The Wall Mount Unit (Roomba Pro Elite only)	14
- <i>Installing the Wall Mount Unit</i>	15
- <i>Using the Wall Mount Unit</i>	16
<b>Caring for Roomba</b>	<b>16</b>
• Emptying the Particle Bin	16
• Replacing the Air Filter	17
• Cleaning the Main Brushes	18
- <i>Reassembling the Brushes</i>	19
• Cleaning the Vacuum Inlet	19
• Maintaining the Edge-Cleaning Side Brush	20
• Keeping Roomba's Sensors Clean	20
<b>Reference Information</b>	<b>21</b>
• Troubleshooting Tips	21
• Frequently Asked Questions	23
• Contacting Customer Support	25
• Limited Warranty to Original Purchaser	26
<b>Purchasing Roomba Accessories</b>	<b>27</b>

# Introducing the Roomba Pro | Pro Elite FloorVac

Welcome to the next generation of Roomba innovation and convenience. The new Roomba Pro and Roomba Pro Elite Robotic FloorVacs have all the great features of the original Roomba, plus many improvements. Roomba Pro and Pro Elite are easier to use and maintain, and feature new ways to clean what you want, where you want, and when you want — at the touch of a button.

Your Roomba Pro | Pro Elite FloorVac is a hard-working, robotic floor-cleaning appliance that eliminates the need to push it or follow it around. It keeps your hard-surface floors and low- to medium-pile carpets barefoot clean with a unique three-stage cleaning process. Roomba effectively cleans most common household floor surfaces with little or no human supervision.

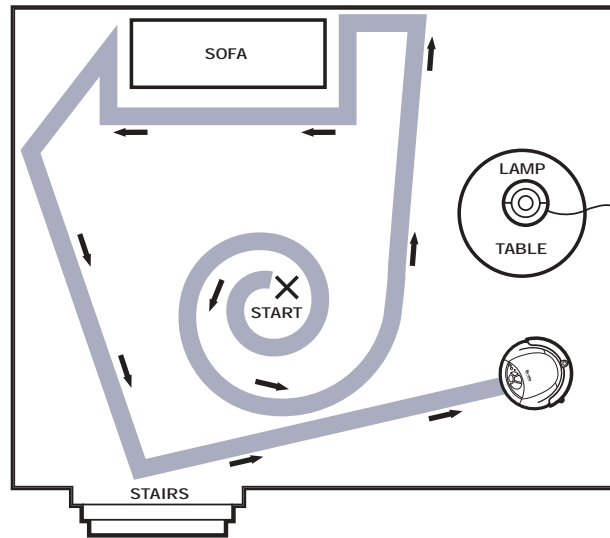


Figure 1: A typical Roomba cleaning pattern.

## How Roomba cleans a room

When Roomba starts a typical cleaning cycle it first travels around the floor in a spiral pattern (see Figure 1). Its Non-Marring Bumper will contact a wall, or it may try to find a wall after spiraling for a while. Roomba follows the wall for a short period of time, using its spinning, Edge-Cleaning Side Brush to move debris away from the wall and into the Vacuum's path. After cleaning along a portion of the wall or other object, Roomba crisscrosses the room in straight lines. For most of Roomba's cleaning cycles, Roomba repeats this cleaning pattern until its cleaning time has elapsed, providing maximum coverage of the room. In new Spot Cleaning mode (new in Pro and Pro Elite), Roomba cleans a 3-foot-diameter area using a slow, high-efficiency spiral pattern. This pattern allows Roomba to focus intense cleaning over a soiled area. In new MAX Cleaning mode (Pro Elite or Remote), Roomba excels at cleaning multiple rooms, or an extra large area — at the touch of a single button.

Roomba Standard Charger  
UL Approved  
Class 2 Transformer  
Input: 120VAC 60Hz 0.3A  
Output: 24VDC 500mA

This device complies with Part 15 of the FCC rules.

Operation is subject to the following conditions:

- (1) this device may not cause harmful interference, and
- (2) this device must accept any interference received, including interference that may cause undesired operation.



# Getting Started

## Unpacking the Box

Remove the contents of the box, and unpack all items from the Styrofoam packing material.

You will have a Roomba Pro | Pro Elite Robotic FloorVac packed for shipping, as well as the following:

1. Rechargeable NiMH Battery (packed inside your Roomba)
2. Charger AC Adapter
3. Two (2) Virtual Wall Units — each unit requires two (2) D-size batteries (not included)
4. Two (2) Replacement Filters
5. Owner's Manual (the document you're reading)
6. Quick Start Guide, Letter from the CEO of iRobot, and Warranty Registration Postcard (not shown in Figure 3)

Roomba Pro Elite also contains:

7. Roomba Remote — requires two (2) AA-size batteries (not included)
8. Wall Mount Unit
9. Five (5) wall anchors for installing the Wall Mount Unit
10. Five (5) screws for screwing into wall anchors or directly into wood, for installing the Wall Mount Unit
11. Five (5) rubber screw hole plugs for finishing the Wall Mount Unit.

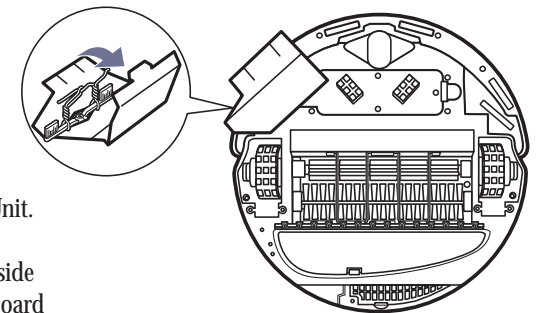
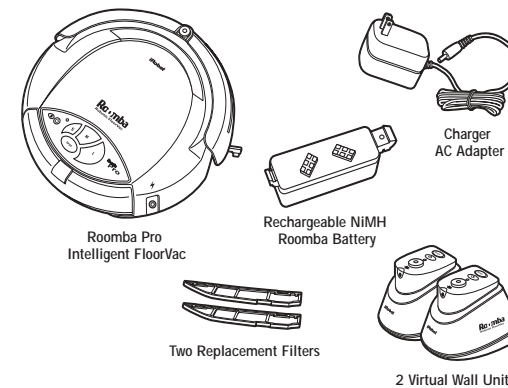


Figure 2: Carefully remove the protective cardboard sheath and twist ties packed around the Spinning Side Brush.

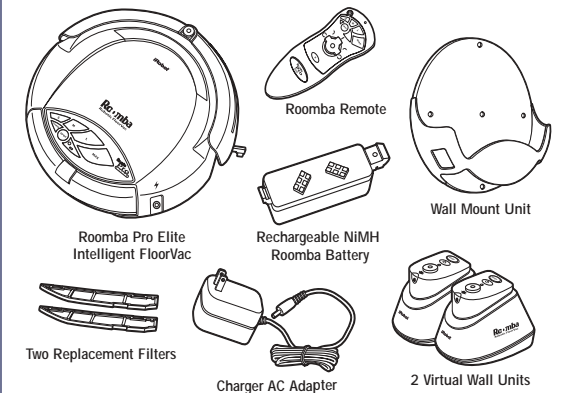
Remove your Roomba from its protective plastic bag and turn it upside down, so the wheels are facing up. You will notice a protective cardboard sheath enclosing the Edge-Cleaning Side Brush (see Figure 2). Carefully disengage the cardboard sheath and twist ties from the black, flexible Side Brush, being careful to protect the Side Brush from damage. Turn your Roomba back over.

Once you have unpacked your Roomba, check to make sure that you have all the parts shown here:

## Figure 3 Contents of package for Roomba Pro.

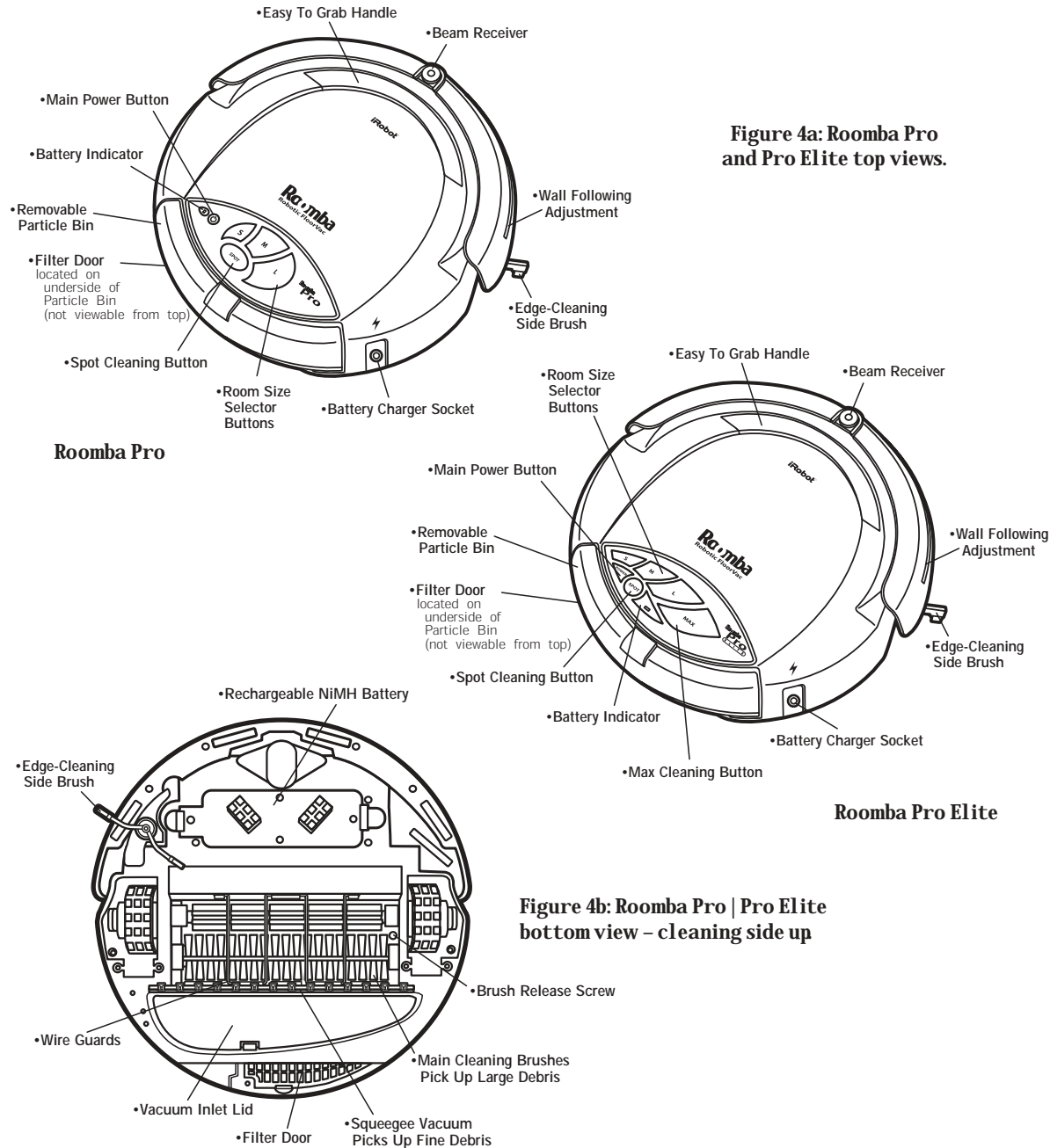


## for Roomba Pro Elite.



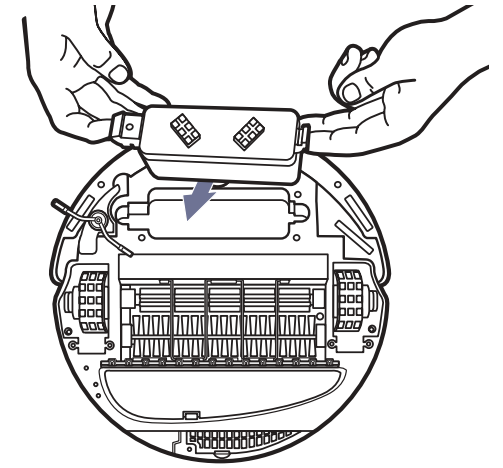
## FloorVac Description

Your Roomba was designed and engineered using the latest technology and includes the following special features:



## Installing the Battery

1. Place Roomba upside down (with Cleaning Brushes showing) on a flat, padded surface such as on a towel or blanket.
2. If you are using Roomba for the first time, remove the Battery from the Battery Compartment, and remove the protective plastic bag from around the Battery. Remove any packing material left inside the Battery Compartment or on the Battery itself.
3. Guide the Battery into the Battery Compartment using your index fingers as shown in Figure 5, and press both sides of the Battery down firmly.
4. The Battery will click flat into place on both sides when properly installed in Roomba.
5. Additional Batteries and a Rapid Charger can be purchased. Please visit [www.RoombaVac.com](http://www.RoombaVac.com) to purchase online, and for more purchase information.



**Figure 5: Installing Roomba's Battery. Be sure to press the Battery firmly down on both sides.**

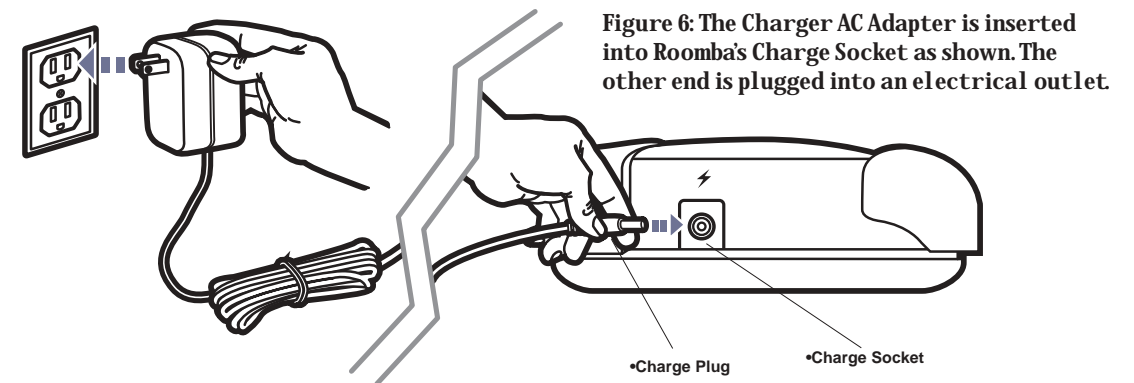
## Removing the Battery

1. Place Roomba upside down on a flat, padded surface.
2. Place your index fingers under the Guide Tabs on the Battery. First pull upward on the side of the Battery nearest the Spinning Side Brush. Then pull the other side of the Battery up and out to remove Battery. If the Battery fails to come free of Roomba, simply press down on the Battery to snap into place, and try again.

## Charging the Battery

Please note that before first use of Roomba, you must charge the Battery. Roomba's built-in charger takes 12 hours to fully charge the Battery.

1. Insert the Charge Plug on the Charger AC Adapter into Roomba's Charger Socket, and plug the other end of the Charger AC Adapter into a standard U.S. electrical outlet (120 Volts AC) as shown in Figure 6.
2. The Battery Indicator Light (beneath the Battery Icon on Roomba's control panel) should slowly pulse yellow. If this fails to occur, remove and reinstall the Battery, check the plug connections and/or the electrical outlet.
3. The Battery Indicator Light will turn off after about 12 hours, with the Battery fully charged.



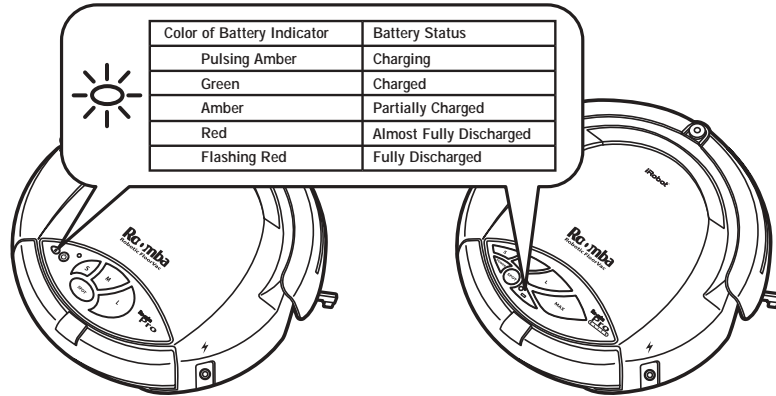
**Figure 6: The Charger AC Adapter is inserted into Roomba's Charge Socket as shown. The other end is plugged into an electrical outlet.**



## The Battery Indicator Light

When Roomba is in operation, the Battery Indicator Light shows the charge level of the Battery according to the chart in Figure 7:

**Figure 7: Understanding the status of the Battery from the Battery Indicator Light.**



### BATTERY NOTES:

1. Roomba can clean 2-3 medium-sized rooms on a single charge. Roomba will run between about 60 minutes (on medium-pile carpet) to about 90 minutes (on hard floor surfaces) on one full charge.
2. If cared for properly, the rechargeable Nickel-Metal Hydride (NiMH) Battery should last for a long time. Like all rechargeable batteries, eventually the Battery will wear out and should be replaced. The Battery may be disposed of in the regular trash.
3. You can purchase additional Batteries, as well as a Rapid Charger that charges a Roomba Battery in about two and a half hours. Contact your nearest Roomba retailer or visit [www.RoombaVac.com](http://www.RoombaVac.com) for online purchase options and more purchase information.

## Using Your Roomba

### Preparing the Room for Cleaning

1. Clear your floor of objects just as you would before using a regular vacuum cleaner: clothing, loose papers, pull cords for blinds or curtains, power cords, and small or fragile items. Because Roomba gently contacts walls, furniture and other objects as it cleans, please remove any items that may be knocked over by light contact from Roomba.

Avoid using Roomba on carpets with long tassels or fringe edges. It may become stuck on long fringe. See the Quick Start Guide for tips. Not recommended for use on shag or deep-pile carpets.

2. Roomba's S, M and L Room Size Buttons are designed to clean one room at a time (see Figure 8). The MAX Cleaning setting (Pro Elite/Roomba Remote only) is designed to clean an extra large room or multiple rooms, but may be used to clean one room intensively. Confine Roomba to the area you want cleaned by closing all doors and use the Virtual Wall Unit to block all open doorways. See *The Virtual Wall Units* on page 11.

Observe Roomba the first time it cleans a room to make sure it doesn't get wedged under or stuck on top of uneven surfaces. Roomba automatically senses stairs and turns away from them. However, if the room to be cleaned contains a balcony, a physical barrier should be used to prevent access to the ledge and ensure safe operation.

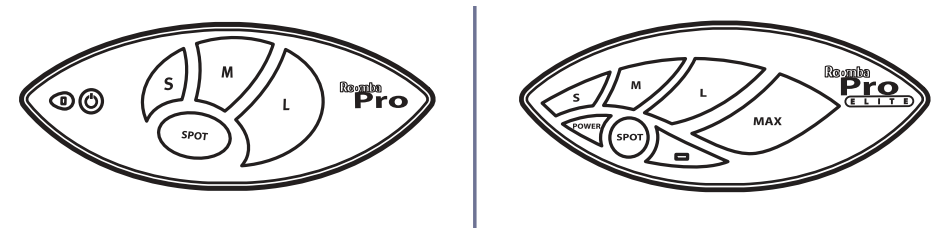
## Starting Roomba

1. Always empty both sides of the Particle Bin before use (a simple process; see *Emptying the Particle Bin* on page 16).
2. Place Roomba on the floor in the middle of an open area in the room. If cleaning multiple rooms with the MAX Cleaning Cycle, begin cleaning in the most central room.
3. Press the green Power Button on top of Roomba to turn it on.
4. Select the cleaning cycle you want according to the chart in Figure 8, and press the corresponding Cleaning Cycle Button to start. Roomba will play a short start-up tune and start the cleaning cycle.

**Note:** If you want to clean a small area up to 3 feet wide, where there is extra dirt or where something dry has spilled, place Roomba in the center of the area to be cleaned and select the Spot Button. Roomba will intensively clean this area. Repeat as necessary.

5. You only need to supervise Roomba the first time it cleans a room. Identify areas where it gets stuck, then move problem objects off the floor or out of the room, modify them or block them with the Virtual Wall Unit provided. Please refer to the *Roomba Care Hints* on the back cover of the Quick Start Guide, as well as *Troubleshooting Tips* on page 21 of this manual to help identify and easily fix problem areas. After this first use, there should be no need to supervise Roomba unless you are operating it around small children or pets.
6. When Roomba is finished cleaning in all cleaning cycles except MAX Cleaning, it will stop and play a cheerful tune. The MAX Cleaning Cycle enables Roomba to clean for the maximum amount of time, until its batteries are fully discharged; consequently, when Roomba finishes a MAX Cleaning Cycle, it will stop and play its "Battery Low" tune. In all cases, all of Roomba's Cleaning Cycle Buttons will glow green, and Roomba will periodically beep for five minutes to remind you that it's done, then turn itself off to conserve power.

**Figure 8: Select the Roomba cleaning cycle that is right for the job.**



PRESS THIS BUTTON	FOR THE FOLLOWING MISSION	APPROXIMATE # OF MINUTES TO COMPLETION
Spot	3' diameter concentrated spot cleaning	1-2
S	Single room, about 10' x 12'	15-25
M	Single room, about 14' x 16'	25-35
L	Single room, about 15' x 20'	34-45
MAX (Roomba Pro Elite and Remote only)	Open floorplan (20' x 30') OR Extra large room OR Intensive single room cleaning	Up to 60-90

## Pausing and Stopping Roomba

Roomba can be paused temporarily during a cleaning cycle, then set back on the cleaning cycle where it left off. Roomba may also be stopped at any time, at which point it will clear the current cleaning cycle to prepare for another.

### Pausing Roomba in a Cleaning Cycle

To temporarily pause Roomba while it's in a cleaning cycle simply pick it up by its handle, or press any button on Roomba except the Power Button. The button corresponding to the cleaning cycle that Roomba has temporarily paused will flash. (Note: If you are using the Roomba Remote, please see additional information in *The Roomba Remote* on page 12.) Note that Roomba will shut itself off, clearing its current cleaning cycle, if it is left paused for more than five minutes.

### Spot Cleaning during a Cleaning Cycle

Roomba can clean a spot one or more times while it is paused in the middle of a cleaning cycle, then continue the cleaning cycle afterward. To Spot Clean during a cleaning cycle, do the following:

1. Pause Roomba.
2. Press the Spot Button. Roomba will play its brief "Spot Cleaning" tune, then start cleaning a 3-foot-wide area.
3. After Roomba completes the Spot Cleaning Cycle (1-2 minutes), it will play its "Done Spot Cleaning" tune, and go back to being paused.

### Un-Pausing Roomba

To un-pause Roomba and continue its cleaning cycle, press any button on Roomba except the Power or Spot Button. Roomba will play its brief "Back to the Cleaning Cycle" tune and start cleaning again where it left off in its cleaning cycle.

### Stopping Roomba

To turn Roomba off, press the Power Button.

*Hint:* If Roomba is moving, you can press any button or lift Roomba up to pause it first before turning Roomba off.

To stop Roomba in order to start a new cleaning cycle, do one of the following:

1. Press the Power Button twice to turn Roomba off then on again. Roomba is now ready to start a fresh cleaning cycle. Empty both sides of the Particle Bin, then press a desired Cleaning Cycle Button to start cleaning.
2. To start Roomba cleaning on a new cleaning cycle quickly, press and hold the desired new cleaning cycle button while it's cleaning, until you hear Roomba play its "Start Up" tune and start the new cleaning cycle.

## The Virtual Wall Units

The Virtual Wall Unit keeps Roomba in the room or area you want cleaned. It uses an invisible beam of light to block 13+ foot-wide open doorways or to close off other large areas. Use the Virtual Wall Unit to block open doorways or clean one portion of a large room. Multiple Virtual Wall Units can be used to block off multiple doorways or open areas, or extra-wide openings. The Roomba Pro and Pro Elite both come with two Virtual Wall Units.

### Virtual Wall Unit Battery Installation

1. Open the Battery Door located on the bottom of each unit by first loosening the screw (see Figure 9).
2. Insert 2 new "D" size alkaline batteries (not included) in each unit by following the "+" and "-" symbols.
3. Replace the Battery Door and tighten the screw.

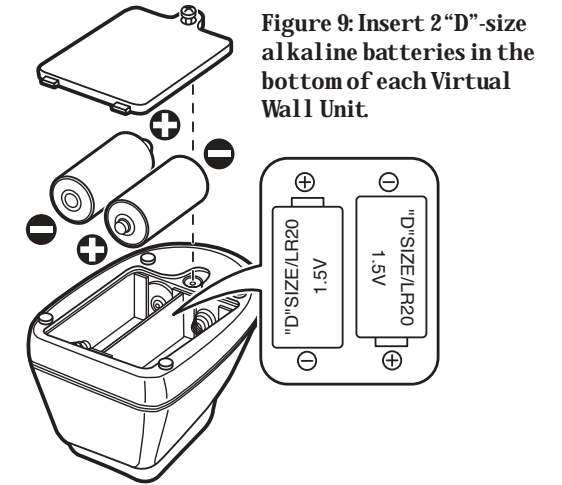


Figure 9: Insert 2 "D"-size alkaline batteries in the bottom of each Virtual Wall Unit.

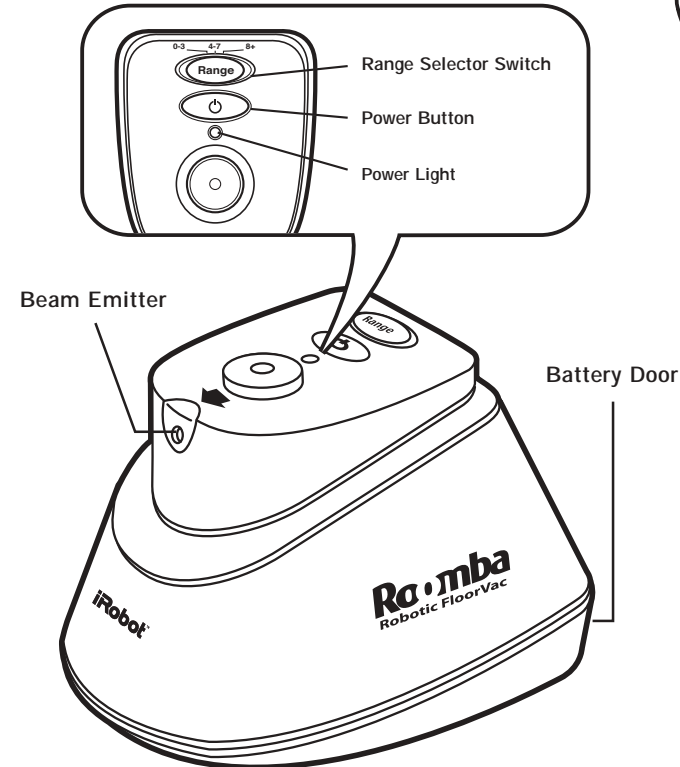


Figure 10a: Close-up of the Virtual Wall Unit.

### CAUTION:

To ensure proper function and avoid battery leakage:

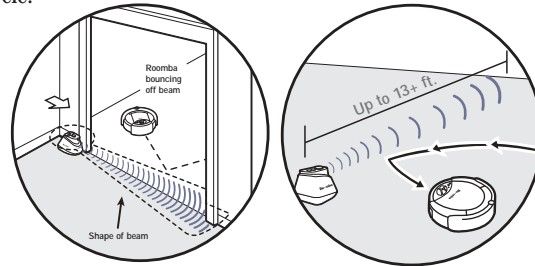
1. Always use alkaline batteries.
2. Do not mix old and new batteries.
3. Do not mix alkaline, standard or rechargeable batteries.
4. Batteries should be installed by an adult.
5. Non-rechargeable batteries are not to be recharged.
6. Rechargeable batteries are to be removed from the product before being charged.
7. Only batteries of the same or equivalent type as recommended are to be used.
8. Batteries are to be inserted with the correct polarity.
9. Exhausted or dead batteries are to be removed from the product.
10. The supply terminals are not to be short circuited.
11. Remove batteries before storing.

## Using the Virtual Wall Unit

1. Press the Virtual Wall Unit's Power Button to turn it on (see Figure 10A. The Power Light on the Virtual Wall Unit will glow green.
2. Move the Range Selector Switch to the room opening size you are blocking. The range numbers shown are in feet.
3. Place the Virtual Wall Unit on the floor at either edge of the doorway or by the wall. Make sure that the Unit's Beam Emitter points across the opening to ensure Roomba does not cross the invisible beam.
4. The Virtual Wall Unit automatically turns off after about two hours, or you can press the Unit's Power Button to turn it off.

**Tip:** Remember to turn on the Virtual Wall Unit each time you start a new cleaning cycle, to prevent the Virtual Wall Unit from shutting down before Roomba has finished its cleaning cycle.

**Figure 10b:** To block an opening, place the Virtual Wall Unit on the floor with the Beam Emitter aimed across the opening. For best results, place the Virtual Wall Unit next to the doorway (as shown). Point the arrow on top of the unit across the open doorway.



Additional Virtual Wall Units may be purchased. Contact your nearest Roomba retailer for availability, or visit [www.RoombaVac.com](http://www.RoombaVac.com) for online purchase options, and for more purchase information.

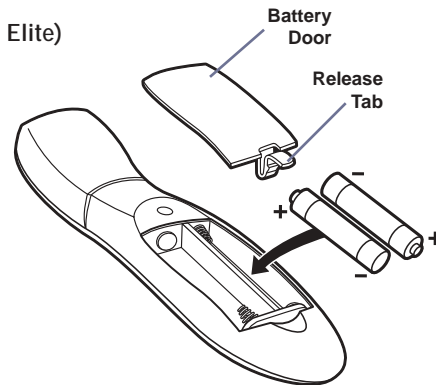
## The Roomba Remote (included with Roomba Pro Elite)

The Roomba Remote allows you to perform a variety of functions with Roomba, some of which can't be performed without the Roomba Remote. The Roomba Remote enables you to turn your Roomba on and off, drive Roomba to specific areas to be cleaned, select and pause cleaning cycles including Spot and Max Cleaning modes — all without bending down to push a single button.

The Roomba Remote is included with Roomba Pro Elite, but is compatible with Roomba Pro (see *Using the Roomba Remote with Roomba Pro* on page 14). The Roomba Remote may be purchased separately; visit [www.RoombaVac.com](http://www.RoombaVac.com) for online purchase options, and for more purchase information. **Note:** the Roomba Remote is not compatible with the original (silver-colored) Roomba model.

### Roomba Remote Battery Installation

1. Open the Battery Door located on the bottom of the Roomba Remote by pressing its Release Tab (Figure 11) and swinging the Battery Door up and out of Remote.
2. Insert 2 new "AA" size alkaline batteries (not included) by following the "+" and "-" symbols.
3. Replace the Battery Door by sliding it into the grooves on the Remote, and swinging the door closed until the Release Tab clicks back into place.

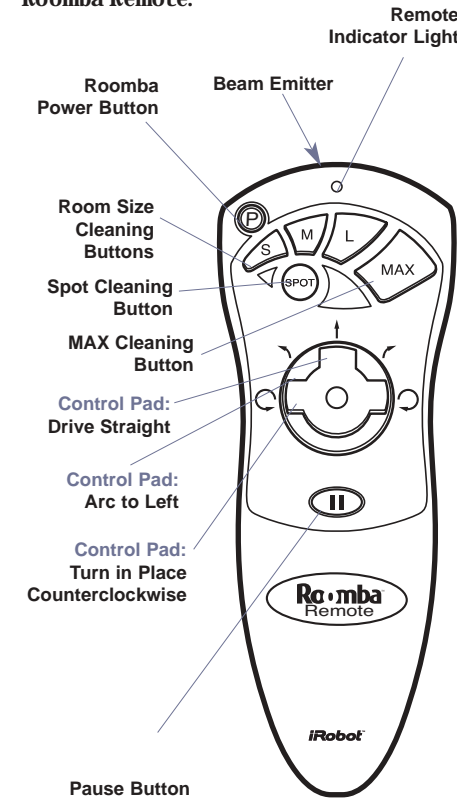


**Figure 11:** Push the Release Tab in on the Battery Door to open, and insert 2 "AA" Alkaline Batteries (not included) in the Roomba Remote.

## Using the Roomba Remote

Your Roomba Remote is designed to be extremely easy to use. Point the Roomba Remote at Roomba Pro | Pro Elite from up to 20 feet away. Below are some important functions of the Remote:

**Figure 12: Controls on the Roomba Remote.**



1. **Powering Roomba Up and Down Remotely:** Press the Power Button on the Remote. If Roomba was off it will turn on with a beep, and its Battery Indicator Light will glow. Press the Power Button again to turn Roomba off. Note: the Power Button on the Roomba Remote only turns Roomba Pro | Pro Elite on and off. Like most other remotes, the Roomba Remote requires no power switch of its own.
2. **Drive Roomba to the Dirt:** Turn Roomba on, and use the Remote's Control Pad (see Figure 12) to drive Roomba where you want it to clean. Roomba cleans as you drive it. To reverse direction, use the Control Pad to turn in place clockwise or counter-clockwise, then drive straight once Roomba is pointed in the desired direction.
3. **Starting, Pausing and Stopping a Cleaning Cycle:** To start Roomba Pro | Pro Elite cleaning with the Remote, either place Roomba in the middle of the room or drive it to the middle of the room (see #2 above). Press the Cleaning Cycle Button on the Remote and Roomba will begin cleaning. The Roomba Remote's Cleaning Cycle Buttons work much as they do on Roomba Pro | Pro Elite. See *Starting Roomba* on page 9 as well as *Pausing and Stopping Roomba* on page 10.
4. **Spot Cleaning with the Remote:** To drive Roomba to a specific area to be cleaned such as spilled plant soil or kitty litter, drive Roomba to the dirt (see #2 above). Once it's in the middle of the soiled area, push the Spot Cleaning button and let Roomba go to work.
5. **Spot Cleaning with the Remote During a Cleaning Cycle:** You can also use the Roomba Remote to interrupt a cleaning cycle and drive Roomba to an area that needs intensive cleaning. Pointing the Remote at Roomba, push the red Pause button on the Remote to pause the current cleaning cycle, and drive Roomba to the new area (see # 2 above). Once you are finished Spot Cleaning, press any Cleaning Cycle Button except the Spot Button to un-pause Roomba and continue the paused cleaning cycle.

### Roomba Remote Notes:

- **Virtual Wall Units and the Roomba Remote:** If you drive Roomba Pro | Pro Elite into the beam of a Virtual Wall, Roomba will beep, but become blinded to commands from the Remote. The Roomba Remote and the Virtual Wall Unit both use Infrared beams, and Roomba's beam receiver can only pick up one beam at a time. For safety reasons, the Virtual Wall Unit's beams always take precedence over the Roomba Remote. In this case, to continue using the Remote, you will need to either pick up Roomba, turn off the Virtual Wall Unit, or wait until the Virtual Wall Unit automatically powers down after two hours.
- **Driving Roomba toward walls or staircases:** If you drive Roomba into a wall or too close to the top of a staircase, it will stop and beep if you try to go forward. Press the left or right side of the Control Pad to turn Roomba in place until Roomba is pointing away from the obstacle. Roomba will now drive forward. It is a good idea to avoid driving Roomba near staircases using the Remote.



- **Keeping tabs on Roomba's state:** The Roomba Remote has all the same buttons as on Roomba Pro | Pro Elite, but its buttons do not light up as they do on Roomba to help keep you informed of Roomba's state. Always look at Roomba to determine it's state.
- **The Pause Button:** The red Pause Button on the Roomba Remote may be pressed during any cleaning cycle to Pause Roomba. This button may be thought of as a "panic button": it only pauses Roomba. Once Roomba is paused, additional presses of this button have no effect.

**Tip:** Can't find Roomba once it's finished its work? Point the Roomba Remote in the general direction that you think Roomba may be hiding. Press the Power Button on the Roomba Remote over and over. If Roomba can "see" the Remote, it will beep to start up.

## Using the Roomba Remote with Roomba Pro

The Roomba Remote is designed for use with Roomba Pro Elite, but is also compatible with Roomba Pro. As an added benefit for Roomba Pro owners, all of the features of Roomba Pro Elite are available to Roomba Pro users, including MAX Cleaning mode. However, this feature works slightly differently with Roomba Pro, as described below.

- **Starting MAX Cleaning with Roomba Pro:** If Roomba Pro is off, turn it on (see Feature #1 in *Using the Roomba Remote* on page 13), and press the MAX Button on the Roomba Remote. Roomba will play its "Starting a Cleaning Cycle" tune and begin a MAX cleaning cycle. Roomba typically lets you know what Cleaning Cycle it's in by illuminating the corresponding Cleaning Cycle Button. Since Roomba Pro does not have a MAX Cleaning Cycle Button, no Cleaning Cycle Button is illuminated while Roomba Pro is in a MAX Cleaning Cycle.
- **Pausing MAX Cleaning with Roomba Pro:** Once in MAX Cleaning Cycle, you can pause the cleaning cycle in a variety of ways — pressing the red Pause Button or any Cleaning Cycle Button on the Remote, picking Roomba Pro up or pressing any Cleaning Cycle Button on Roomba Pro. When Roomba is paused, it typically lets you know what Cleaning Cycle is paused by flashing the corresponding Cleaning Cycle Button. Since Roomba Pro does not have a MAX Cleaning Cycle Button, no Cleaning Cycle Button is flashing while Roomba Pro is paused during a MAX Cleaning Cycle. In this case, Roomba Pro's control panel may look a bit confusing. Here's how to tell that Roomba is paused in a MAX Cleaning Cycle: If none of the Cleaning Cycle buttons are illuminated, and the Battery Indicator Light is not flashing red, then Roomba is paused in a MAX Cleaning Cycle.

Beyond these two instances, the Roomba Remote will operate the same way it does with Roomba Pro Elite.

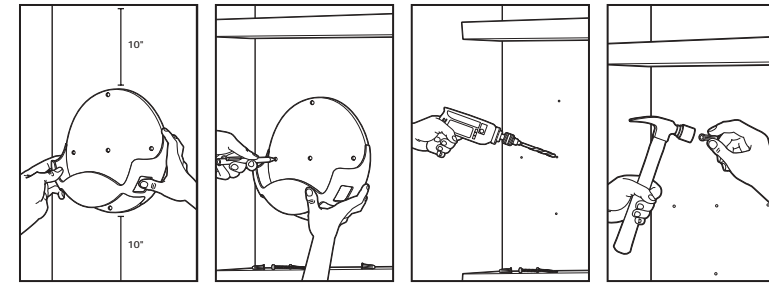
## The Wall Mount Unit (Roomba Pro Elite only)

The Wall Mount Unit included with Roomba Pro Elite gives you a convenient, compact storage solution for Roomba. The Wall Mount Unit easily mounts to a variety of wall surfaces, and is designed to provide easy access to empty the Particle Bin and charge Roomba while stored. All the hardware needed to mount the unit are included with Roomba Pro Elite. The Wall Mount Unit fits all Roomba and Roomba Pro models, and is available as an accessory. Visit [www.RoombaVac.com](http://www.RoombaVac.com) for online purchase options, and for more purchase information.

### Installing the Wall Mount Unit

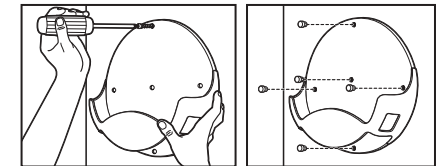
To install the Wall Mount Unit you will need a drill, a 1/4" drill bit or 1/8" drill bit (see below to determine which is best for your needs), a hammer, a pencil, and a #2 Phillips Screwdriver.

1. Remove all protective packing material from around the Wall Mount Unit.

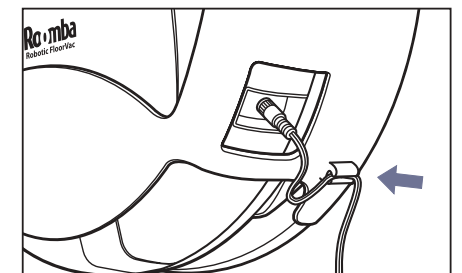


**Figure 13a-d (Pro Elite only):** Preparing to mount the Wall Mount Unit. Hold up the Wall Mount Unit as shown on the wall where you want to store Roomba, leaving enough clearance above and below the Unit (Figure 13a). Using a pencil, mark the locations of the holes to be drilled on the wall (Figure 13c). Remove the Wall Mount Unit and drill the five pilot holes in the wall. Hammer the wall anchors into the holes (Figure 13d).

2. Determine a suitable location for the Wall Mount Unit. Be sure to leave at least 10" of clearance above the Wall Mount Unit (beneath any shelving, for instance) to lift your Roomba in and out comfortably. Also, leave 10" of clearance below the Wall Mount Unit to empty Roomba's Particle Bin while stowed (Figure 13a). If possible, find a location near enough to an electrical outlet for the Charger AC Adapter to reach the Wall Mount Unit. **Note:** Roomba fits snugly in the Wall Mount Unit. It may require some force to lift Roomba out. Be sure to position Roomba in a location where you have plenty of leverage.
3. Using a pencil, mark the locations of the holes to be drilled on the wall (Figure 13c).
4. Remove the Wall Mount Unit and drill the five pilot holes in the wall. Use a 1/4" drill bit to use the included wall anchors (best for drywall or plaster), or an 1/8" drill bit if using just the included screws without wall anchors (best for wood). If using the wall anchors, hammer the wall anchors into the holes until they are flush with the wall surface (Figure 13d).
5. Affix the Wall Mount Unit to the wall by screwing in the included screws with a #2 Phillips screwdriver (Figure 14a).
6. Insert the rubber screw hole plugs into the screw holes to finish installation (Figure 14b).
7. Press the Charger AC Adapter's cord into the Charge Cord Pincer on the bottom right side of the Wall Mount Unit as shown, and plug the Charger AC Adapter into a standard U.S. electrical outlet.



**Figure 14a-b (Pro Elite only):** Securing the Wall Mount Unit. Affix the Wall Mount Unit to the wall by screwing in the included screws with a #2 Phillips screwdriver (Figure 14a). Insert the rubber screw hole plugs into the screw holes to finish installation (Figure 14b).



**Figure 15 (Pro Elite only):** Trap a few inches of the Charger AC Adapter's cord in the Charge Cord Pincer on the bottom right side of the Wall Mount Unit for easy charging when Roomba is stowed away.

### Using the Wall Mount Unit

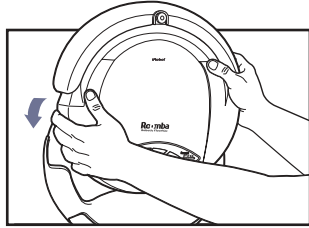
Roomba may be stored and charged in the Wall Mount Unit as needed in between floor cleanings. To lift Roomba in and out of the Wall Mount Unit, firmly grasp Roomba's handle in one hand and use the other hand to steady Roomba. Alternatively, you can grasp Roomba securely with both hands (Figure 16).



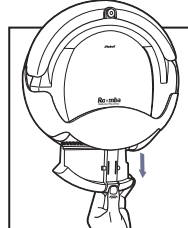
Note: Roomba fits snugly in the Wall Mount Unit, so it may require some force and a little practice to lift Roomba out easily.

To empty Roomba while stored in the Wall Mount Unit (Figure 17), simply follow the instructions for *Emptying the Particle Bin* on this page. To charge Roomba in the Wall Mount Unit, simply plug the Charge Plug into Roomba's Charge Socket. Be sure to remove the Charge Plug from Roomba before lifting Roomba in and out.

**Important:** The Wall Mount Unit is for Roomba only. It will not support additional weight.



**Figure 16 (Pro Elite only):** Grasp Roomba with two hands to lift Roomba in and out of the Wall Mount Unit.



**Figure 17 (Pro Elite only):** Emptying Roomba's Particle Bin while mounted. When stowed, Roomba's Handle will extend to help lift Roomba out for next use.

## Caring for Your Roomba

Your Roomba requires a few simple maintenance steps:

- The Particle Bin. Before each use, you should empty both sides of Roomba's Particle Bin (this page).
- The Main Cleaning Brushes must also be removed, checked and cleaned after every ten floor cleanings — every five floor cleanings if pet hair or long hair are issues in your home. **Note:** *Failure to regularly remove and clean the Main Brushes may result in poor performance or malfunction.* Caring for the Cleaning Brushes involves completely removing them (page 18) to examine and clean the Brush Axles, as well as the Brushes themselves.
- The Vacuum Inlet Lid should periodically be checked for debris under the clear lid, and cleaned as needed (page 19).
- The Four Sensor Areas underneath the Front Bumper should be checked periodically, and dusted off as needed (page 20).

### Emptying the Particle Bin

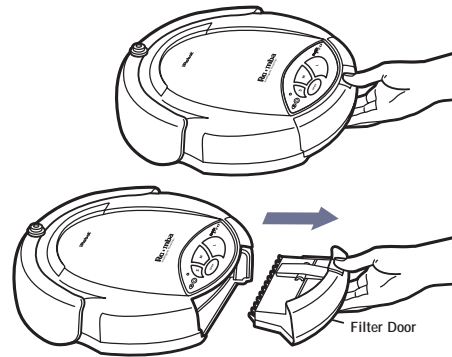
Emptying Roomba's Particle Bin is a two-step process. Be sure to empty both sides of the Particle Bin before each use.

#### Step 1: Emptying the Main Bin (the back side)

1. If Roomba is on, press the green Power Button to turn it off.
2. Press down on the Particle Bin's Release Tab and keep it depressed while pulling the Particle Bin straight back (Figure 18a-b).
3. Empty the Particle Bin into a trash receptacle.

#### Step 2: Emptying the Particle Bin's Filter Chamber (the bottom side)

1. Flip the Particle Bin over to access the Filter Door.
2. Release the small Tab on the Filter Door and pull the Filter Door upward (Figure 19).
3. Empty debris from the Filter Chamber into a trash receptacle. If necessary, gently brush lint or other debris from the interior of the air filter.
4. To reinstall, slide the Filter Door into place (Figure 20a). The Filter Door will click when it reattaches itself to the Particle Bin (Figure 20b).



**Figure 18a-b: Emptying Roomba's Particle Bin.** Press the Release Tab (Figure 18a) and Pull the Particle Bin out (Figure 18b). The Filter Door is on the underside of the Particle Bin.

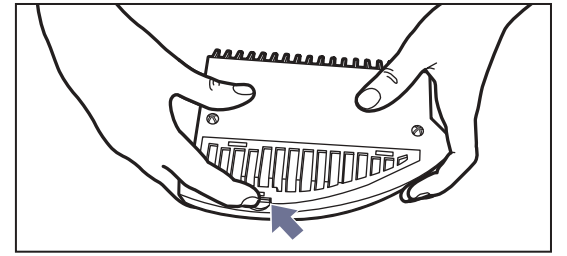
5. To reinstall the Particle Bin, slide it back into Roomba. The Particle Bin will click when it is properly seated.

**NOTE:** Always carry Roomba by its handle and never tilt it forward, as debris may spill out of the particle bin.

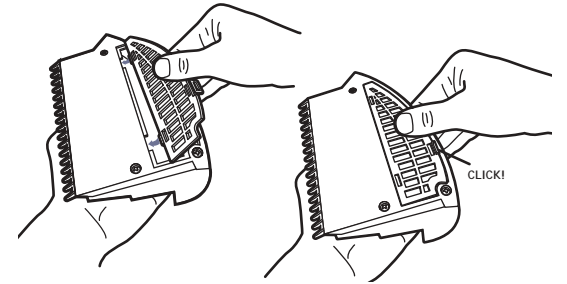
## Replacing the Air Filter

The Air Filter (located in the Filter Door underneath Roomba's Particle Bin) needs to be replaced if it becomes punctured or if you notice a decline in the cleaning performance of Roomba. Two spare Replacement Filters are included with Roomba; additional Replacement Filters are available for purchase in packs of three. Visit [www.RoombaVac.com](http://www.RoombaVac.com) for more purchase information, or contact your nearest Roomba retailer for availability.

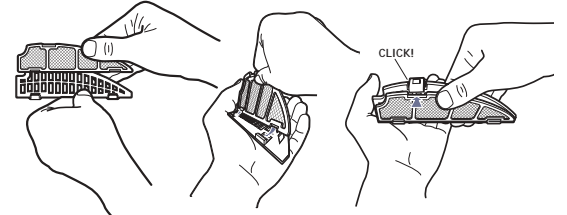
1. If Roomba's power is on, turn it off.
2. Remove the Particle bin. (see Figure 18a-b).
3. Flip the Particle Bin over to access the Filter Door.
4. Release the small Tab on the Filter Door and pull the Filter Door upward (Figure 19).
5. Unclip the old Air Filter from the Filter Door Frame (Figure 21a).
6. Slide the new Air Filter into the grooves on the Filter Door Frame (Figure 21b).
7. Click the new Filter into the Filter Door Frame as shown in Figure 21c.
8. To reinstall the Filter Door, slide the Filter Door into place (Figure 20a). The Filter Door will click when it reattaches itself to the Particle Bin (Figure 20b).



**Figure 19: Accessing the Filter Chamber.** Open the Filter Door on the bottom of the Particle Bin by releasing the small Tab on the Filter Door as shown and pulling the Tab upward. Clean the debris from this chamber each time you empty the Particle Bin.



**Figure 20a-b: Reinstalling the Filter Door.** Glide the Filter Door into grooves (Figure 20a), and snap the Filter Door into place (Figure 20b).



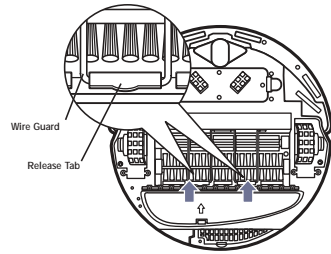
**Figure 21a-c: Snap out old filter from Filter Door Frame (Figure 21a). Slide new Filter into grooves on Filter Door Frame (Figure 21b). Snap new Filter into Filter Door Frame as shown (Figure 21c).**

# Cleaning the Main Brushes

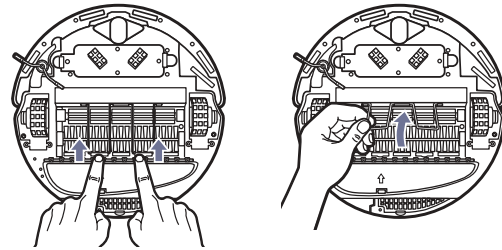
It is important that you regularly remove and clean the Main Cleaning Brushes of your Roomba. Debris can accumulate around the Brushes and the Brush ends, or axles, causing a decrease in cleaning ability and potentially damaging the unit. If the Main Brushes are not cleaned regularly your Roomba may seriously malfunction.

In most households it's a good idea to clean the Main Cleaning Brushes after every ten floor cleanings. In houses with pets or long hair, clean the Brushes after every five floor cleanings. The Main Cleaning Brush axles cannot be checked without removing the Brushes from Roomba. It is a simple process that you will master quickly with a little practice.

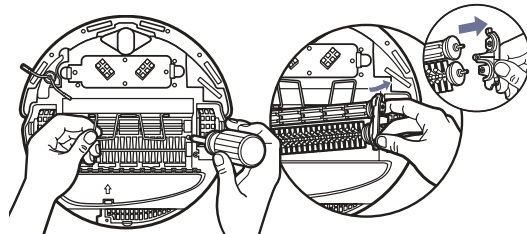
1. If Roomba's power is on, turn it off. Empty the Particle Bin and place Roomba upside down (cleaning surface up) on a flat, padded surface such as a towel, with the Front Bumper facing away from you.
2. Unlatch the Wire Guards that cover the Main Cleaning Brushes from the two Release Tabs (Figure 22): Push down on the Wire Guards to flatten and elongate them, and pull the front edge of the Wire Guard (the edge nearest you) toward you to swing it up and over both Release Tabs to expose Brushes. (see Figure 23a-b).
3. Using a Phillips-head screwdriver, completely loosen the screw in the Brush Coupler, the component that holds the Brushes in place on the right side of the unit (Figure 23c). Note that the screw will not come all the way out of the Brush Coupler so you cannot lose it. Pull up the Brush Coupler (see inset in Figure 23d). The Main Cleaning Brushes will come up with the Brush Coupler.
4. Pull the Brush Coupler off the end of the Brushes, then pull the Brushes to the right and up, out of Roomba (Figure 23d).
5. Clean any hair or other debris off the Brushes.
6. Completely clean any debris from around the Brush Axles (Figure 24).



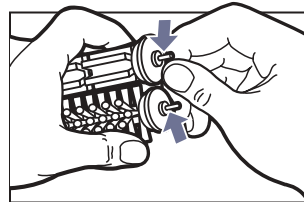
**Figure 22: The Wire Guards properly installed under the two Release Tabs.**



**Figure 23a-b: Unlatch the Wire Guards from the two Release Tabs by pushing down on the Wire Guards to flatten and elongate them, and pulling the front edge of the Wire Guard toward you to swing it up and over each Release Tab. Once the Wire Guards have been freed from the Release Tabs, they can be swung up and away, exposing the Main Cleaning Brushes.**



**Figure 23c-d: Completely loosen the screw on the Self-Adjusting Cleaning Deck with a #2 Phillips screwdriver, then pull out the plastic Brush Coupler and the two Main Cleaning Brushes. If there is a thumbscrew on the Brush Coupler, you may be able to loosen the screw by turning the thumbscrew with your fingers.**



**Figure 24: Clean and remove any debris built up or wound around the ends and metal axles of both Cleaning Brushes.**

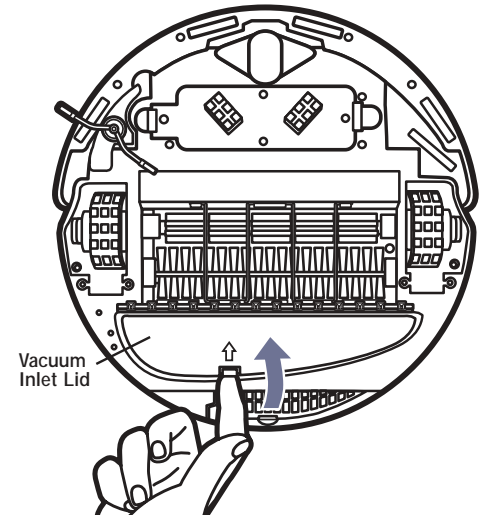
## Reassembling the Brushes

1. Put the Self-Adjusting Cleaning Deck back together by inserting the square ends of the two Brushes into the square sockets in the Cleaning Deck.
2. Insert the other ends of the Brushes into the small holes in the Brush Coupler.
3. Lower the Brush Coupler into its slot and screw it into place.
4. Swing the Wire Guards back in place and snap them down into their slots in front of the Release Tabs.

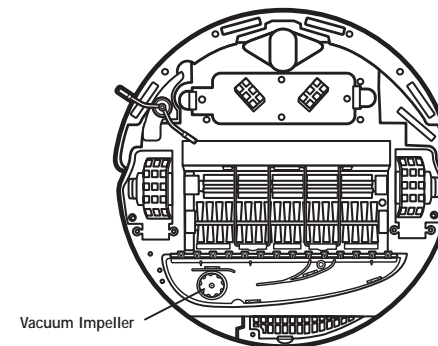
## Cleaning the Vacuum Inlet

Over time, debris will accumulate in the Vacuum Inlet. Empty the Vacuum Inlet every 10 floor cleanings or so to keep air flowing freely, especially if you notice a decline in Roomba's cleaning performance.

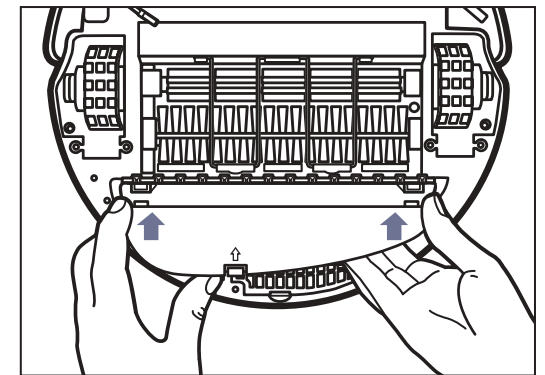
1. If Roomba is on, turn it off and empty the Particle Bin.
2. Place Roomba upside down (cleaning surface up) on a flat, padded surface with the front Bumper facing away from you.
3. Press in the white rectangular Release Tab on the Vacuum Inlet Lid to release the latch (Figure 25a), and pull upward to remove the Lid.
4. Shake the debris into a trash receptacle.
5. Turn the Vacuum Impeller, the fan-shaped mechanism on the left side of the Vacuum Inlet, with your finger to make sure that it spins freely (Figure 25b).
6. Guide the hinge tabs on the Vacuum Inlet Lid back into their holes (Figure 25c), and press in and down on the white rectangular Release Tab to snap the Lid securely back in place.



**Figure 25a: Removing the Vacuum Inlet Lid.**



**Figure 25b: Make sure the Vacuum Impeller is free of debris and can spin freely.**

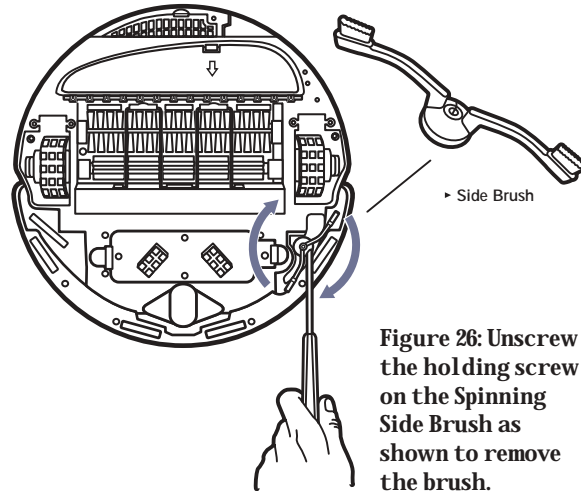


**Figure 25c: Reinstalling the Vacuum Inlet Lid.**

## Maintaining the Edge-Cleaning Side Brush

Periodically check the Edge-Cleaning Side Brush by spinning it to ensure debris has not built up underneath it. If it seems to be obstructed, remove and clean the Edge-Cleaning Side Brush as follows:

1. If Roomba is on, turn it off and empty the Particle Bin. Turn Roomba over so the cleaning surface is up. Place it on a flat, padded surface.
2. Turn the Edge-Cleaning Side Brush so the Screw Head can be accessed (see Figure 26). Point the screw head towards Roomba's Front Bumper, as shown below.
3. Using a small Phillips-head screwdriver, unscrew the holding screw.
4. Pull the Edge-Cleaning Side Brush up and off of Roomba.
5. Clean out any hair or other debris that may have been caught under the Side Brush or on the Side Brush Shaft.
6. Push the Side Brush back onto the Side Brush Shaft. Screw the holding screw securely into the Edge-Cleaning Side Brush, being careful not to over-tighten.

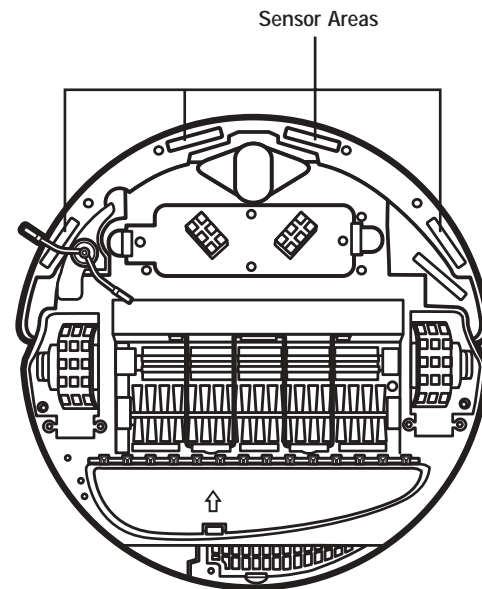


**Figure 26: Unscrew the holding screw on the Spinning Side Brush as shown to remove the brush.**

## Keeping Roomba's Sensors Clean

Occasionally, lint or other debris will collect in Roomba's key sensor areas, which may cause Roomba to exhibit unexpected movement behavior. If this happens, clean these areas as follows:

1. If Roomba is on, turn it off and empty the Particle Bin. Turn Roomba over so the cleaning surface is up. Place it on a flat, padded surface.
2. Using a cotton swab, check and clean out any lint or other debris from the four recessed sensor areas located under the Front Bumper (Figure 27).



**Figure 27: Make sure that all four recessed sensor areas under the front bumper are kept free of dust and debris.**

## Reference Information

### Troubleshooting Tips

**My Roomba turns on, beeps and shuts off.**

Roomba's Main Cleaning Brush axles may be clogged with hair or other debris.

1. Make sure Roomba is fully charged and the Battery is properly seated.
2. If Roomba is charged, then empty the Particle Bin (see *Emptying the Particle Bin* on page 16) and follow the instructions for removing and cleaning the Main Brushes (see *Cleaning the Main Brushes* on page 18). Pay special attention to the Brush ends, or axles.

**My Roomba is not working or there has been a decrease in the cleaning performance.**

1. Ensure that the Battery is properly seated and charged.
2. Check that the Particle Bin (including the Filter Chamber) and Vacuum Inlet are empty, and that the Vacuum Impeller, (the fan-shaped mechanism on the left side of the Vacuum Inlet) spins freely. (See the entire section entitled *Caring for Your Roomba Pro*, beginning on page 16 for more information.)
3. While you are examining the Filter Chamber, check the Air Filter (attached to the Filter Door) to make sure it is not clogged or damaged.
4. Remove and examine all Brushes and their axles to make sure there is nothing wound around them (see *Cleaning the Main Brushes* on page 18 as well as *Maintaining the Edge-Cleaning Side Brush* on page 20). Also check to see there is nothing wound around the Wheels or Wheel Axles.

**My Roomba Gets Stuck.**

Your Roomba may occasionally get stuck, especially in rooms that it has not cleaned before. If it does get stuck, Roomba will try to free itself by turning in different directions. If it cannot free itself, Roomba will pause its cleaning cycle, flash its Room Size Buttons and beep periodically for five minutes to let you know it's stuck, before shutting off to conserve power. Your Roomba might get stuck for several reasons:

1. It is wedged or pinned between or under narrowly spaced objects.
2. A cord, string, long rug fringe or carpet tassel is wound around its Brushes or Wheels.
3. One of the Wheels is no longer in contact with the ground.
4. Roomba bumps into objects and repositions them in such a way that an exit path no longer exists.

Move or block any object that Roomba gets stuck on or under. See the illustration entitled "Roomba Care Hints" on the back cover of the Quick Start Guide to help identify and easily fix these problem areas. Once the problem areas have been fixed, press the flashing Cleaning Cycle Button to continue Roomba's cleaning cycle. If you wish to begin a new cleaning cycle, press Roomba's Power Button to turn it off, then turn it on again. Make sure the Particle Bin is empty and select the desired Cleaning Cycle Button to start a new cleaning cycle

**My Roomba Remote doesn't work.**

1. Make sure the Roomba Remote has new batteries.
2. Make sure that Roomba is operational by turning it on and off with the Main Power Button on Roomba. If Roomba won't turn on, check that Roomba's Battery is charged and completely installed.
2. Check that Roomba's Beam Receiver (see Figure 3A) is clean by wiping it with a soft, dry cloth. Clean the Roomba Remote's transmitter area (on the front end of the Remote) by wiping it with a soft, dry cloth.
3. Make sure you are close enough to Roomba for the Remote to work. Try pointing the Roomba Remote at your Roomba from less than 20 feet away, press the Power Button on the Roomba Remote and wait to hear Roomba's Start-Up beep. Ensure you are pointing the correct end at Roomba.



Part of my Roomba has broken.  
Please call Roomba Customer Support at 1-877-855-8593.

**My Virtual Wall Unit is not working.**

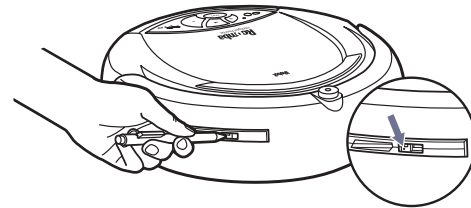
1. Check that new batteries are installed, and that the unit is turned on.
2. Make sure the Beam Emitter is pointed across the opening you want to block.
3. If that does not work, turn the Virtual Wall Unit's Range Selector Switch up to the maximum setting for large openings.
4. Some very large openings require that more than one Virtual Wall Unit be used. You can purchase additional Virtual Wall Units by going to your nearest Roomba retailer, or visiting [www.RoombaVac.com](http://www.RoombaVac.com) for online purchase options, and for more purchase information.

**Roomba Battery will not charge.**

1. Ensure that the Charger AC Adapter is plugged into a working outlet. Try several outlets to be sure.
2. Make sure that the Charger AC Adapter is fully plugged into Roomba. No metal should be visible once the plug is fully inserted. See *Charging the Battery* on page 7.
3. Check that the Battery is properly inserted. To be sure, remove it, inspect the contacts on the Battery and in Roomba to make sure they are not blocked by dirt, then reinsert the Battery. It should click into place on each side.
4. The Battery Indicator Light on Roomba (under the Battery Icon) should pulse yellow. If it does not glow at all, check all the connections. The Battery Indicator Light will turn off when the Battery is fully charged.

**My Roomba moves too close to or far from my walls.**

1. If the Edge-Cleaning Side Brush does not clean close enough to the wall, use a pen to push the Adjustment Tab toward the rear of the Bumper (see Figure 28). This will make Roomba follow closer to walls.
2. If the Edge-Cleaning Side Brush is bumping into the wall, use a pen to push the Adjustment Tab toward the center of the Bumper. This will make Roomba follow further away from walls.



**Figure 28: Using a pen to adjust how close or far away Roomba will follow walls.**

**My Roomba Pro Elite doesn't clean for long in MAX Cleaning mode.**

MAX Cleaning Cycle enables Roomba to clean until its batteries are fully discharged. If the battery is partially discharged when starting a MAX Cleaning Cycle, Roomba will not clean for as long as it would on a full charge.

1. Make sure the battery is fully charged.
2. Check that both sides of the Particle Bin are empty before you start Roomba.

**I can't find the answer to my question in the Manual.**

1. Additional Troubleshooting Tips may be found by visiting the Support section of [www.Roombavac.com](http://www.Roombavac.com).
2. Send email to [roomba-support@irobot.com](mailto:roomba-support@irobot.com), or call the toll-free Customer Support Line at 1-877-855-8593.

## Frequently Asked Questions

Q: Why doesn't my Roomba clean my floor in straight lines?

A: Roomba uses an algorithm-based cleaning pattern to clean your home most efficiently. For all cleaning cycles except Spot Cleaning, when Roomba starts cleaning it travels around the floor in a spiral pattern (see Figure 1 on page 4). Its Non-Marring Bumper will contact a wall, or it may try to find a wall after spiraling for a while. Roomba follows the wall for a short period of time, using its spinning, Edge-Cleaning Side Brush to move particles away from the wall and into the Vacuum's path. After cleaning along a portion of the wall or other object, Roomba criss-crosses the room in straight lines. Roomba repeats this cleaning pattern until its cleaning time has elapsed. This sophisticated navigation ensures that Roomba will clean your whole room as thoroughly as possible.

Q: Are pets and children safe around Roomba?

A: Roomba has been designed with a number of safety features, including automatically shutting off when it is picked up or gets stuck. Children and pets should always be supervised around Roomba for optimum safety and cleaning performance.

Q: Does Roomba clean corners and along the walls?

A: Roomba has a spinning, Edge-Cleaning Side Brush that cleans next to walls, most corners and other tough-to-reach places.

Q: Will it go under kickboards, beds, and furniture?

A: Roomba has been designed to fit under the kickboards in your kitchen. If your bed or other furniture is more than 4" off the floor, Roomba will happily clean underneath.

Q: What powers Roomba?

A: Roomba is powered by a NiMH Rechargeable Battery.

Q: How much suction power does Roomba have?

A: Roomba uses a unique, three-stage cleaning system. The spinning, Edge-Cleaning Side Brush sweeps debris from corners and edges of the room into Roomba's main cleaning path. Two counter-rotating Cleaning Brushes sweep up larger particles, while a small, extremely efficient squeegee vacuum sucks up the smaller particles. This allows Roomba to get impressive cleaning performance using only 30 Watts, much less power than is required by traditional upright vacuums.

Q: How long will the Battery's charge last?

A: The life of a fully-charged Battery depends on the floor surface to be cleaned. A single charge can last from about 60 minutes (on medium pile carpet) to about 90 minutes (on hard floor surfaces).

Q: How many rooms will Roomba clean before the Battery needs to be recharged?

A: It depends on the floor surface to be cleaned. For typical operation, Roomba cleans three 14' x 16' medium-size rooms.

Q: How long does it take to recharge the Battery?

A: The built-in battery charger and Charger AC Adapter that comes with Roomba takes up to 12 hours to recharge the Battery. The optional Rapid Charger accessory recharges a Battery in about two and a half hours. Contact your nearest Roomba retailer for availability, or visit [www.RoombaVac.com](http://www.RoombaVac.com) for online purchase options and more purchase information.



- Q: Where can I purchase additional Batteries?  
A: You can purchase additional Batteries by contacting your nearest Roomba retailer, or by visiting [www.RoombaVac.com](http://www.RoombaVac.com) for online purchase options and more purchase information.
- Q: How is the original Roomba different from Roomba Pro and Pro Elite?  
A: All three models use the same breakthrough cleaning technology. Roomba Pro features the new Spot Cleaning cycle, which enables you to clean 3-foot-wide areas intensively in 1-2 minutes. Roomba Pro also comes with a second Virtual Wall Unit. Roomba Pro Elite features Spot Cleaning as well as the new MAX Cleaning Cycle, which allows Roomba to clean an open floor plan, a very large room, or multiple rooms by cleaning for up to 90 minutes, much longer than it does on the L Cleaning Cycle. The Pro Elite also comes with a Wall Mount Unit for convenient mounting and storage, as well as a second Virtual Wall Unit. Roomba Pro Elite also comes with the Roomba Remote (see *The Roomba Remote* on page 12).
- Q: How does the Virtual Wall Unit work?  
A: The Virtual Wall Unit is used to block open doorways and confine Roomba in a room. The Unit can also be used to divide a large room and force Roomba to clean just one side of the room. The Virtual Wall Unit sends a harmless, invisible beam across the opening, confining Roomba to the area where you want it.
- Q: Where can I purchase additional Virtual Wall Units?  
A: You can purchase additional Virtual Wall Units by contacting your nearest Roomba retailer, or by visiting [www.RoombaVac.com](http://www.RoombaVac.com) for online purchase options and more purchase information.
- Q: Does the Particle Bin need to be emptied? Does the Filter need to be cleaned? How often?  
A: Debris from both sides of the Particle Bin (which includes the Air Filter) should be emptied after each use. See *Caring for Your Roomba Pro* on page 16 for more information.
- Q: How can I get extra Replacement Air Filters?  
A: The Air Filter needs to be replaced if it becomes punctured or if you notice a decline in the cleaning performance of Roomba. Two spare Replacement Filters are included with Roomba; additional Replacement Filters are available for purchase in packs of three. Visit [www.RoombaVac.com](http://www.RoombaVac.com) for more purchase information, or contact your nearest Roomba retailer for availability.
- Q: Will Roomba clean all floor surfaces?  
A: Roomba is great at cleaning hard floor surfaces including hardwood, linoleum, laminate, and tile. Roomba is quite good at cleaning low- to medium-pile carpet as well. Roomba is not designed to operate on deep-pile or shag carpets, or rugs with long tassels or fringe.
- Q: Do I need to change the floor adjustment when changing floor surfaces?  
A: No, Roomba's Self-Adjusting Cleaning Head automatically adjusts to different floor surfaces as it cleans carpet, hardwood, linoleum, and tile.
- Q: Will Roomba sweep water from the floor?  
A: No, Roomba should not be used to pick up any liquid including water.

- Q: Will Roomba fall down stairs or into a step-down room?  
A: Roomba automatically senses stairs and turns away from them. However, if the room to be cleaned contains a balcony, a physical barrier should be used to prevent access to the balcony and ensure safe operation.
- Q: If Roomba gets stuck, what should I do?  
A: Help Roomba get unstuck, then press the flashing Room Size Button to continue Roomba's cleaning cycle. Please refer to the illustration entitled "Roomba Care Hints" on the back cover of the Quick Start Guide, as well as *Troubleshooting Tips* on page 21 for more information.
- Q: Is Roomba safe to use when I leave my home?  
A: Roomba can operate unattended, so long as small children and pets are not present to interfere with Roomba's operation, and loose objects have been picked up.
- Q: Does Roomba pick up pet hair?  
A: Roomba picks up pet hair very effectively from carpet as well as hard surfaces. As with most vacuums, if pet hair is an issue in your house you may need to pay special attention to caring for the appliance. Empty the Particle Bin (page 16) and remove and clean the Main Cleaning Brushes (page 18) more frequently to reduce the chance of clogging. Removing and cleaning the Main Brushes after every five room cleaning is recommended in these cases.
- Tip:* If there is a lot of pet hair in the room (such as the first time Roomba cleans the room), the Cleaning Head will pick up a great deal of it. If the room is medium-sized or larger, you may want to use the "S" (Small Room) setting a few times, allowing Roomba to stop cleaning after a short period of time so you can remove the collected pet hair. Upon completion of this process, you should be able to run Roomba on longer cleaning cycles (for longer cleaning periods), with a reduced chance of clogging from pet hair.
- Q: When I turn on Roomba, the Battery Indicator Light is green, but quickly turns to red. Why is that?  
A: Even when they are nearly completely drained, most batteries tend to recover their charge a small amount after they are rested. In this case, Roomba's Battery needs to be recharged.
- Q: Do you offer spare parts?  
A: Please contact us with your request. Email us at [roomba-support@irobot.com](mailto:roomba-support@irobot.com) or call toll-free 1-877-855-8593.
- Q: How can I find out more about Roomba?  
A: The Roomba website, [www.RoombaVac.com](http://www.RoombaVac.com), is full of detailed information about the Roomba Robotic FloorVac. You can also go to the Roomba User's Forum to chat with other Roomba users about their experience. To join the forum, go to: <http://groups.yahoo.com/group/roomba-users/join>

## Contacting Customer Support

If you cannot find the answer to your question in this Manual or on the [www.RoombaVac.com](http://www.RoombaVac.com) website, please send email to [roomba-support@irobot.com](mailto:roomba-support@irobot.com), or call our toll-free Customer Support Line at 1-877-855-8593.

## Limited Warranty to Original Purchaser

This Roomba brand product, as supplied and distributed by iRobot Corporation, and delivered new, in the original carton to the original customer purchaser, is warranted by iRobot Corporation par against manufacturing defects in materials and workmanship for the qualifying limited warranty period as follows:

### ONE HUNDRED EIGHTY (180) DAYS LABOR AND PARTS

This limited warranty begins on the original date of purchase, and is valid only on products purchased and used in the United States, and does not include installation, removal or reinstallation. Warranty repairs must be performed by iRobot Corporation's authorized service center. To receive warranty service, the original dated bill of sale must be presented upon request as proof of purchase to iRobot Corporation's authorized service center. To obtain warranty service, support, or other information, please visit our website at [www.RoombaVac.com](http://www.RoombaVac.com). If you do not have web access, please call 1-877-855-8593.

iRobot Corporation will repair or replace this product, at our option and at no charge with new or reconditioned parts, if found to be defective during the limited warranty period specified above. To request service, the purchaser must contact iRobot Corporation for problem determination and service procedures. iRobot Corporation does not warrant uninterrupted or error-free operation of the product. All replaced parts and products become the property of iRobot Corporation and must be returned to iRobot. Replacement parts and products assume the remaining original warranty, or sixty (60) days, whichever is longer.

This limited warranty covers manufacturing defects in materials and workmanship encountered in normal, and, except to the extent otherwise expressly provided in this statement, non-commercial use of this product and shall not apply to the following, including, but not limited to: damage which occurs in shipment; applications and uses for which this product was not intended; failures or problems which are caused by products or equipment not supplied by iRobot Corporation; accidents, misuse, abuse, neglect, misapplication, fire, water, lightning or other acts of nature; incorrect electrical line voltage, fluctuations or surges; damage caused by improper installation; product alteration or modification; improper or unauthorized repair; exterior finish or cosmetic damage; failure to follow operating instructions, customer adjustments, maintenance and environmental instructions that are covered and prescribed in the instruction book; use of non-iRobot or unauthorized parts, supplies, accessories or equipment which damage this product or result in service problems; failures or problems due to incompatibility with other equipment.

THERE ARE NO EXPRESS WARRANTIES OTHER THAN THOSE LISTED AND DESCRIBED ABOVE, AND NO WARRANTIES WHETHER EXPRESS OR IMPLIED, INCLUDING, BUT NOT LIMITED TO, ANY IMPLIED WARRANTIES OF MERCHANTABILITY OR FITNESS FOR A PARTICULAR PURPOSE, SHALL APPLY AFTER THE EXPRESS WARRANTY PERIOD STATED ABOVE, AND NO OTHER EXPRESS WARRANTY OR GUARANTEE GIVEN BY ANY PERSON, FIRM OR CORPORATION WITH RESPECT TO THIS PRODUCT SHALL BE BINDING ON IROBOT CORPORATION. IROBOT CORPORATION SHALL NOT BE LIABLE FOR LOSS OF REVENUE OR PROFITS, FAILURE TO REALIZE SAVINGS OR OTHER BENEFITS, OR ANY OTHER SPECIAL, INCIDENTAL OR CONSEQUENTIAL DAMAGES CAUSED BY THE USE, MISUSE OR INABILITY TO USE THIS PRODUCT, REGARDLESS OF THE LEGAL THEORY ON WHICH THE CLAIM IS BASED, AND EVEN IF IROBOT HAS BEEN ADVISED OF THE POSSIBILITY OF SUCH DAMAGES. NOR SHALL RECOVERY OF ANY KIND AGAINST IROBOT CORPORATION BE GREATER IN AMOUNT THAN THE PURCHASE PRICE OF THE PRODUCT SOLD BY IROBOT CORPORATION AND CAUSING THE ALLEGED DAMAGE.

WITHOUT LIMITING THE FOREGOING, PURCHASER ASSUMES ALL RISK AND LIABILITY FOR LOSS, DAMAGE OR INJURY TO PURCHASER AND PURCHASER'S PROPERTY AND TO OTHERS AND THEIR PROPERTY ARISING OUT OF THE USE, MISUSE OR INABILITY TO USE THIS PRODUCT SOLD BY IROBOT CORPORATION NOT CAUSED DIRECTLY BY THE GROSS NEGLIGENCE OF IROBOT CORPORATION. THIS LIMITED WARRANTY SHALL NOT EXTEND TO ANYONE OTHER THAN THE ORIGINAL PURCHASER OF THIS PRODUCT, IS NONTRANSFERABLE AND STATES YOUR EXCLUSIVE REMEDY.

Some states do not allow limitations on how long an implied warranty lasts, or the exclusion or limitation of incidental or consequential damages, so the above limitations or exclusions may not apply to you. This warranty gives you specific legal rights and you may also have other rights which vary from state to state.

## Roomba Accessories

The following accessories are available for purchase. Contact your nearest Roomba retailer for availability, or visit [www.RoombaVac.com](http://www.RoombaVac.com) for online purchase options and more purchase information.



### Rapid Charger

Recharges Battery in about 2.5 hours!

Part #02004



### Extra Battery

Keep charged Batteries ready to go!

Part #02002



### Additional Virtual Wall Unit

Close off extra large openings, or close off more than one opening at a time!

Part #02003



### Replacement Filter 3-Pack

Part #02005